

BZ00

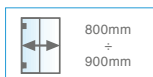

8mm



800mm
÷
900mm

• Kit Hip-zac ad angolo. Sezione tonda. Per piatto 800÷900mm.

• Kit Hip-zac angular. Sección redonda. Plato de ducha 800÷900mm.

• Hip Zac corner kit. Round section. Shower tray size 800÷900mm.

• Schiebetürsystem Hip Zac für Ecke. Rundschnitt. Duschwanne 800÷900mm.

• Kit d'angle Hip-zac. Section ronde. Pour bac de douche 800÷900mm.

HIP-ZAC system

BZ00K

composto da / composed of



4 x BZ10



2 x BZ51



1 x BZ57

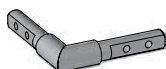

1 x BZ20



2 x BZ30



4 x BZ70



2 x BZ45

+

BZ0K40

composto da / composed of

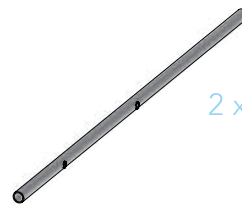

2 x BZ40



2 x BZ55



BZ00

HIP-ZAC system

DATI (Data)	L = min 800 ÷ max 900	(mm)
DATI (Data)	P = 400	(mm)
DATI (Data)	LM = 390	(mm)
CALCOLARE (Calculate)	LF = (SCHEMA)	(mm)

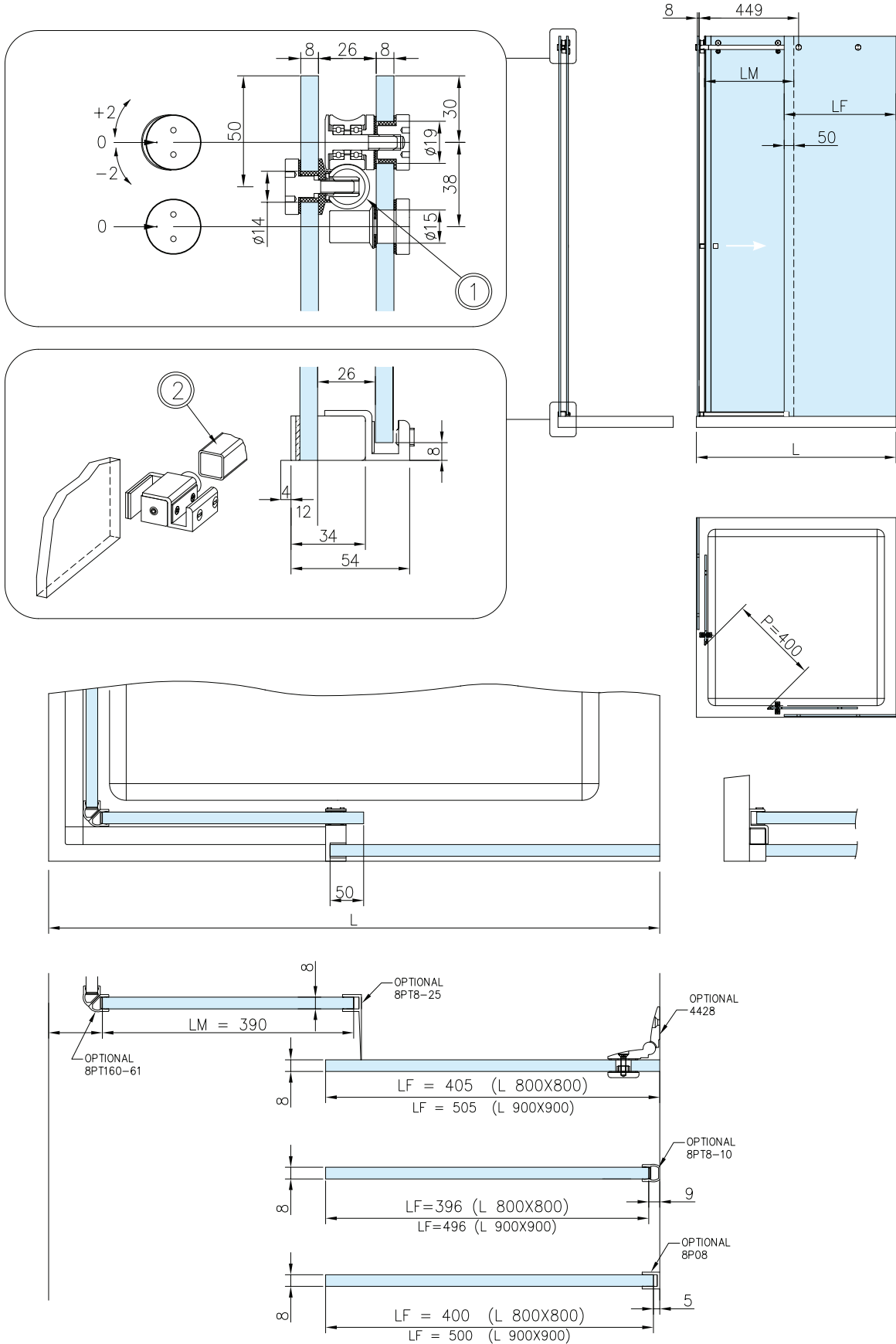

BZ00

HIP-ZAC system

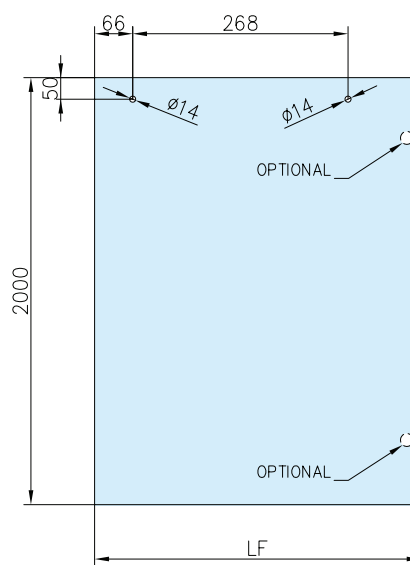
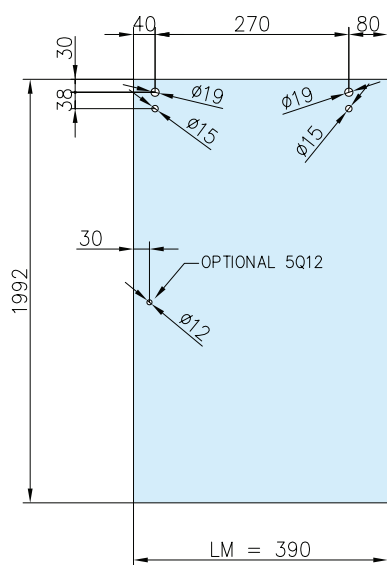

① D.20x2

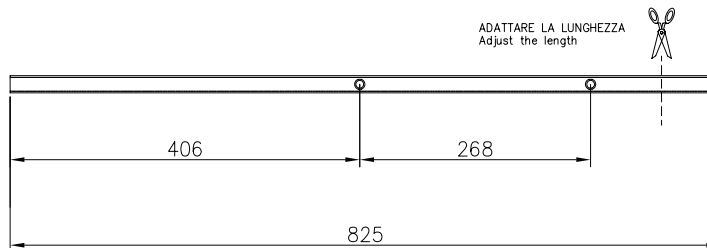

② 20x20x1.5

