

8500

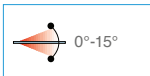

- Cerniera a scatto per box doccia. Stop a 0° +90° -90°.
- Bisagra con retención para box ducha. Tope a 0° +90° -90°.
- Clicking hinge for shower boxes. Stop at 0° +90° -90°.
- Duschtürpendelband Glas-Wand, Feststellung bei 0°+90°-90°.
- Charnière à retenue pour cabine de douche. Arrêt à 0° +90° -90°.

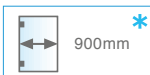
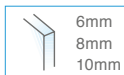
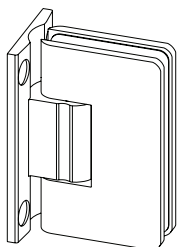

- * • Per porte con peso superiore ai 40 kg e di larghezza oltre i 700 mm si consiglia l'utilizzo di n° 3 cerniere
- Para puertas con un peso superior a los 40 kg y con más de 700 mm de ancho se aconseja utilizar 3 bisagras
- For doors with weight higher than 40 Kgs and largeness higher than 700 mm we suggest to use 3 hinges
- Für Türe mit größerem Gewicht als 40 Kgs und größerer Breite als 700 mm schlagen wir die Verwendung von 3 Beschlägen vor
- Pour des portes d'un poids supérieur à 40 kg et d'une largeur supérieure à 700 mm, nous conseillons d'utiliser 3 charnières

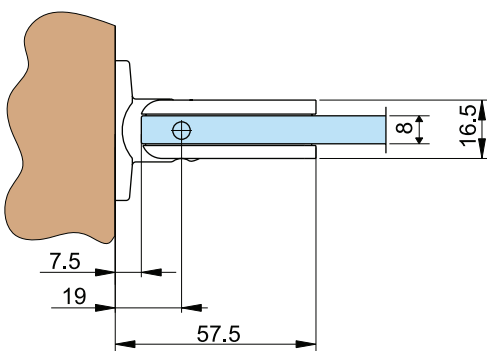
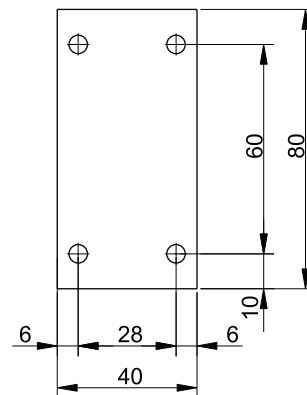
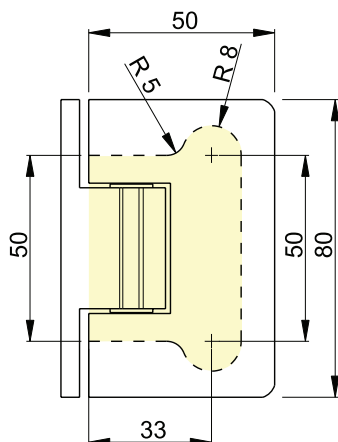

8501

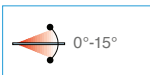
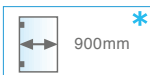
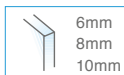

- Cerniera a scatto per box doccia con aletta spostata. Stop a 0° +90° -90°.
- Bisagra con retención y aleta desplazada para box ducha. Tope a 0° +90° -90°.
- Clicking hinge with offset fixing wing for shower boxes. Stop at 0° +90° -90°.
- Duschtürpendelband Glas-Wand, mit einseitiger Montageplatte, Feststellung bei 0°+90°-90°.
- Charnière à retenue pour cabine de douche avec platine déportée. Arrêt à 0° +90° -90°.

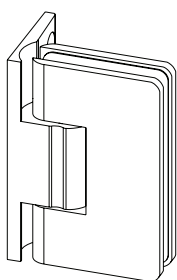

- * • Per porte con peso superiore ai 40 kg e di larghezza oltre i 700 mm si consiglia l'utilizzo di n° 3 cerniere
- Para puertas con un peso superior a los 40 kg y con más de 700 mm de ancho se aconseja utilizar 3 bisagras
- For doors with weight higher than 40 Kgs and largeness higher than 700 mm we suggest to use 3 hinges
- Für Türe mit größerem Gewicht als 40 Kgs und größerer Breite als 700 mm schlagen wir die Verwendung von 3 Beschlägen vor
- Pour des portes d'un poids supérieur à 40 kg et d'une largeur supérieure à 700 mm, nous conseillons d'utiliser 3 charnières

