

ESPRO:

QUOTE PROFILI

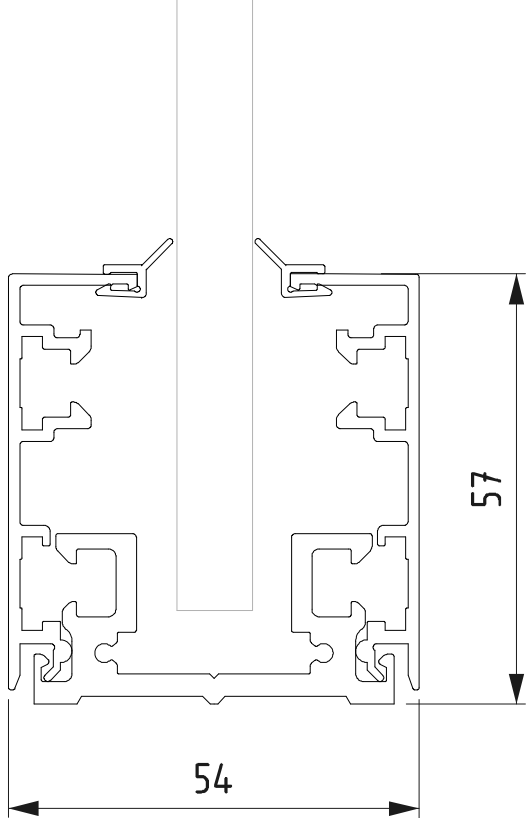

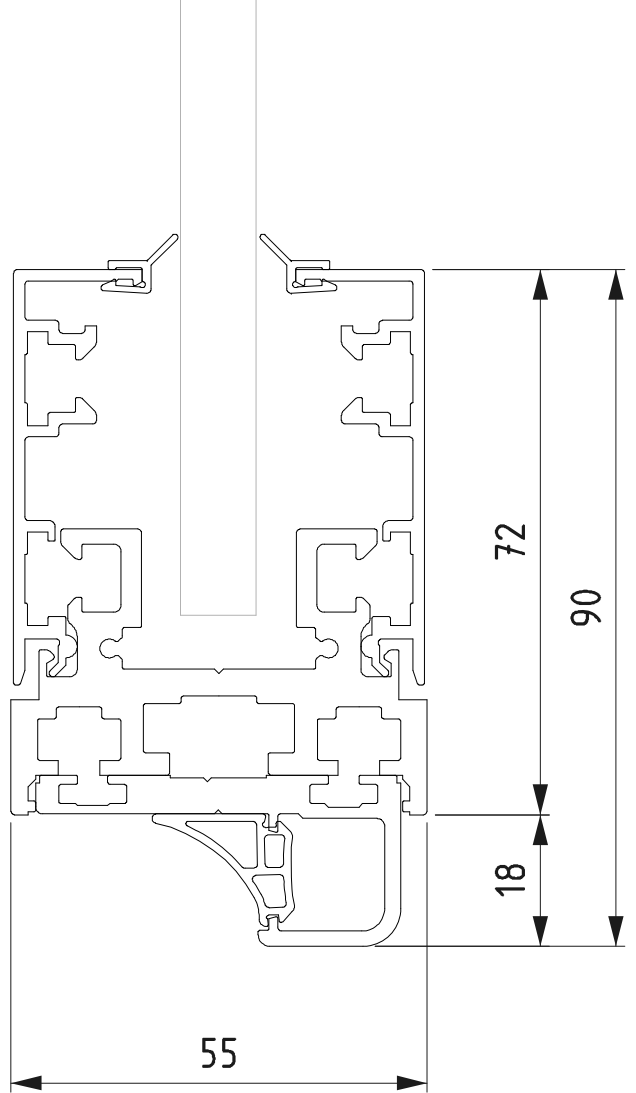

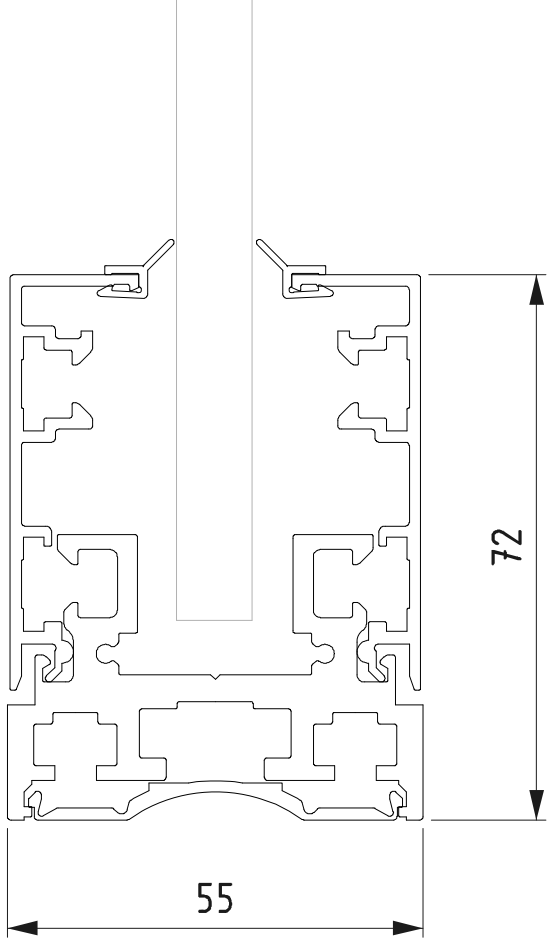

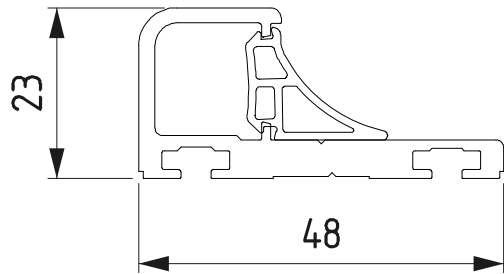
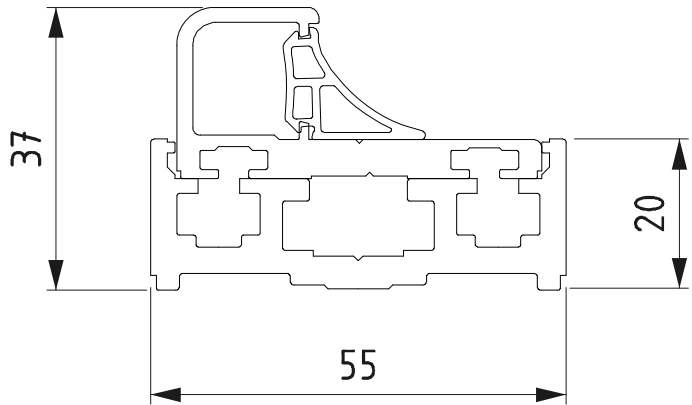

PCC01

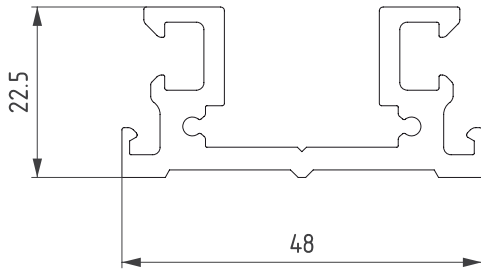

PCC02

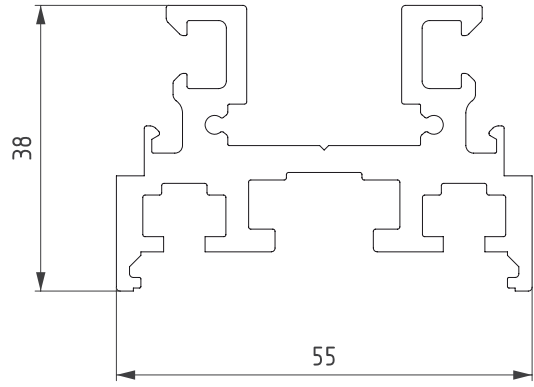

PCC03

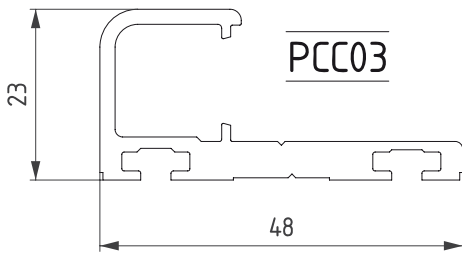

PCC05

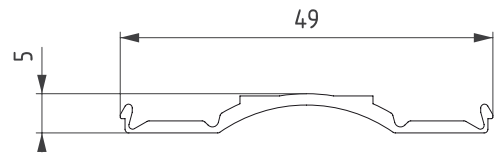

PCC04

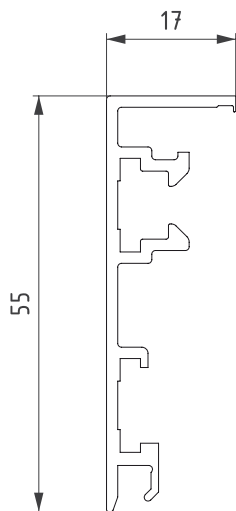

PCC08

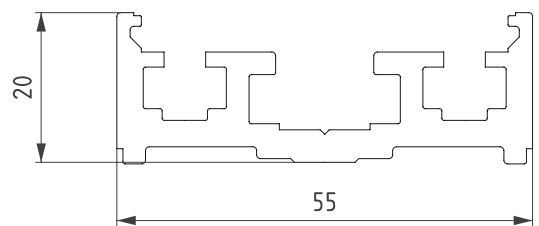

INGOMBRI DEL
PROFILO

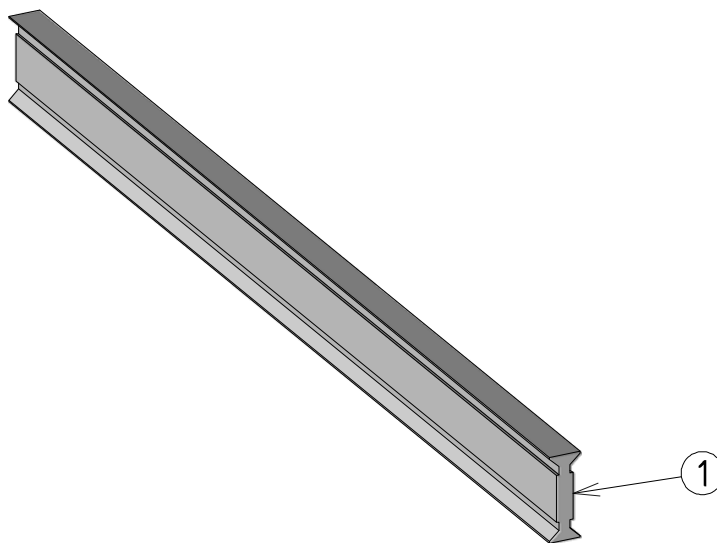
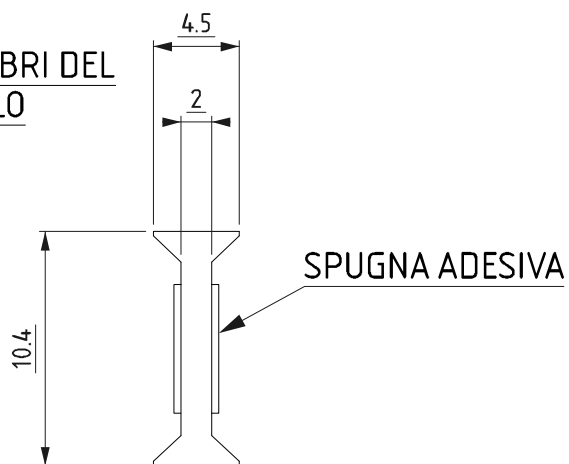

1	1	PROFILO FERMAVETRO 2 VIE	policarbonato	PCC14
Pos	Q.TA'	DESCRIZIONE	MATERIALE	CODICE
 <p>colcom Dettagli essenziali per il vetro temperato</p>		<p>Questo disegno è di nostra esclusiva proprietà, a termine di legge ne è vietata la comunicazione a terzi e la riproduzione</p>		
		Formato dis A4	Scala 1:1	Materiale:
		Quantità: -	Peso Grezzo Kg -	Stato:
Rev	Modifica	Data:	Dis.	Disegnato da: Renzo Ceresoli
A				Data: 27/05/2009
B				Tolleranze gen. +/-0.1
C				Lunghezza Taglio:
D				Approvato da:
				Trattamento Termico: -
				Codice Materiale:
				Denominazione: PROFILO FERMAVETRO 2 VIE
				Disegno n°: PCC14
T:\TOPSOLID\SAIPRO\PCC14\PCC14.dft				

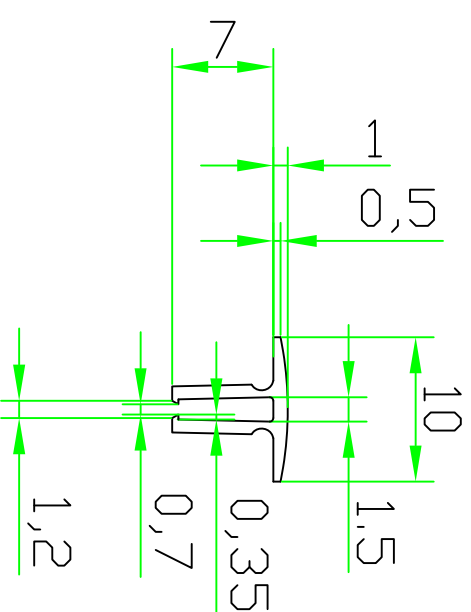
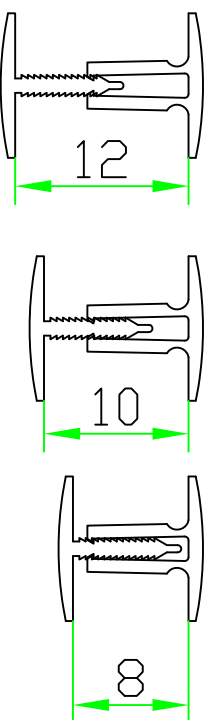

AZIONE MOLLA

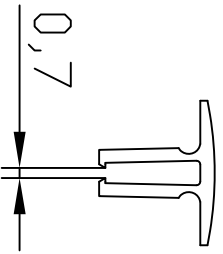
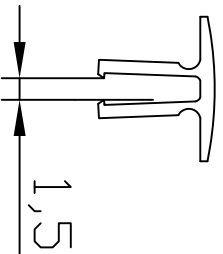
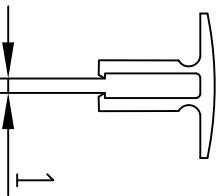
	AZIONE MOLLA	
<p>A RIPOSO</p>  <p>0,7</p>	<p>MASSIMA ESTENSIONE</p>  <p>1,5</p>	<p>POSIZIONE DI LAVORO</p>  <p>1</p>

